

CWK / CFK
Circular duct coolers
for cooled water

CWK

Circular duct coolers for cooled water

The CWK with circular duct connection uses chilled water as the energy carrier and is used for cooling the ventilation air in a ventilation system. The CWK can also be used for cooling individual rooms or zones. For controlling the room or supply air temperature, the duct cooler is supplemented with regulators, sensors, actuators, valves and anti-freeze protection.

- 7 standard sizes
- Circular duct connection with rubber seals
- Casing of Aluzinc-coated sheet steel, AZ 185
- Openable cover for inspection and cleaning
- Stainless steel drip tray for collecting the condensate
- Air tightness class C to EN 15727

Design

The casing is made of Aluzinc-coated sheet steel, AZ 185. The coil has copper tubes and tube connections, and aluminium fins. An openable cover simplifies inspection and cleaning. Stainless steel drip tray for condensate collection, with G $\frac{1}{2}$ " drain connection. The duct connections have rubber seals. The duct coolers conforms to airtightness class C to EN 15727.

Operating data

Max. operating temp.: +150°C
 Max. operating press.: 1,0 MPa (10 bar)
 The coils are pressure tested and tested for leakage.

Capacity

Examples of capacity for each size are given on pages 6 and 7. You can also do your own calculations using our web-based VEAB Select calculation program (www.veab.com), or get in touch with our sales technicians for assistance.

Installation

The CWK is designed for installation in a horizontal duct.

Control

See pages 8 to 10 for a list of regulators, sensors, valves and actuators.

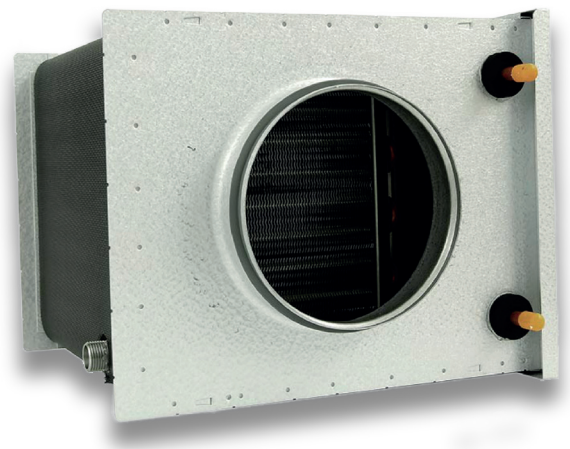

Air tightness class C

The CWK duct cooler conforms to air tightness class C, which ensures that the heated air will reach its destination and will not leak out of the ventilation system – which saves energy and money.

Product range overview and dimensions

Type	∅ D mm	B mm	H mm	∅ dy mm	F mm	G mm	K mm	L mm	Coil inside volume l	Weight kg
CWK 100-3-2.5	100	251	180	10	100	30	280	340	0.15	4
CWK 125-3-2.5	125	326	255	10	175	35	280	350	0.4	6
CWK 160-3-2.5	160	326	255	10	175	40	280	350	0.4	6
CWK 200-3-2.5	200	411	330	22	250	40	280	350	0.7	9
CWK 250-3-2.5	250	486	405	22	325	40	280	360	1.1	11
CWK 315-3-2.5	315	560	504	22	400	40	280	360	1.61	15
CWK 400-3-2.5	400	710	529	22	425	55	332	442	2.5	20

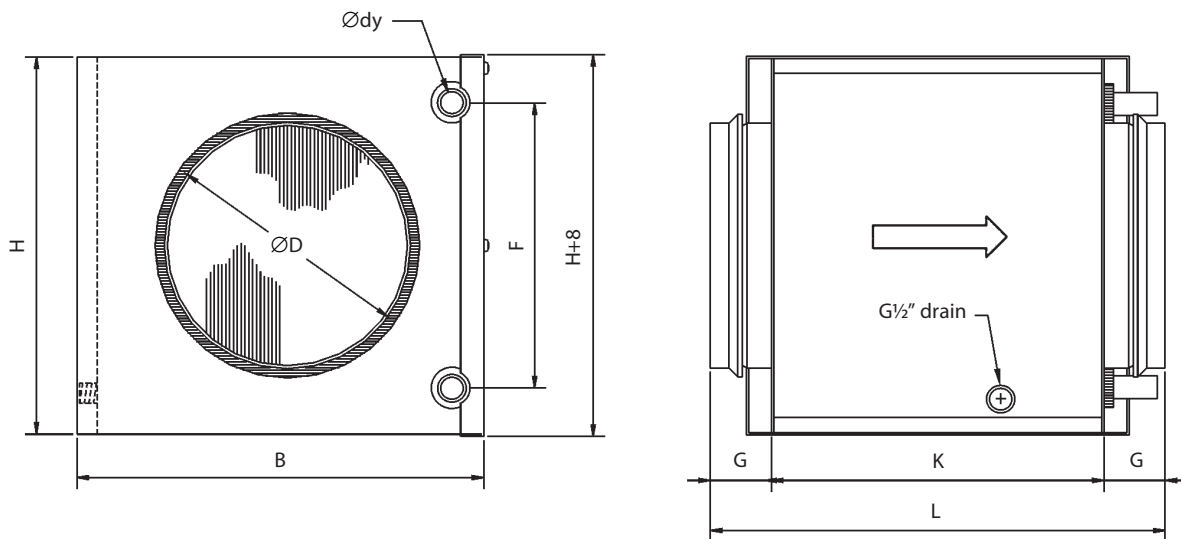

Project design/ordering

Descriptive text for - CWK

VEAB type CWK duct cooler with casing made of Aluzinc-coated sheet steel, AZ 185, coil with copper tubes and tube connections, and with aluminium fins. Stainless steel drip tray for condensate. The duct cooler conforms to air tightness class C. The cooler is controlled by an external regulator, sensors, valves and actuators, which must be ordered separately.

Specify the following for project ordering:

1. Air flow rate: - m³/h
2. Inlet air temperature: - °C
3. Outlet air temp. or required output: - °C or kW
4. Duct size: - mm
5. Inlet water temperature: - °C
6. Outlet water temp. or water flow: - °C or l/sec
7. Inlet air humidity: - % RH
8. Anti-freeze agent: - type / %

Type designation **CWK 100 - 3 - 2.5**

(example)

Size designation

Number of tube rows

Fin pitch, mm

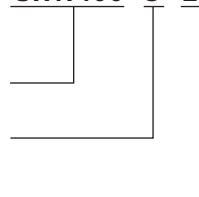

CFK

Circular duct coolers for cooled water, insulated

The CFK with circular duct connection uses chilled water as the energy carrier and is used for cooling the ventilation air in a ventilation system. The CFK can also be used for cooling individual rooms or zones. For controlling the room or supply air temperature, the duct cooler is supplemented with regulators, sensors, actuators, valves and anti-freeze protection.

CFK is supplied with double-casing and insulated with 50 mm mineral wool. The insulation minimises energy loss, and exterior condensation. CFK has an openable cover, making it easy to clean the coil and condensation trough. Regular cleaning ensures efficiency, and is important for hygiene.

- 6 standard sizes
- Double-jacket casing made of aluzinc-treated steel plate AZ 185
- Insulated with 50 mm mineral wool.
- Openable cover for inspection and cleaning
- Stainless steel drip tray for collecting the condensate
- Circular duct connection with rubber seals
- Air tightness class C to EN 15727

Design

Double-jacket casing made of aluzinc-treated steel plate AZ 185 with 50 mm mineral wool insulation.

The coil has copper tubes and tube connections, and aluminium fins. An openable cover simplifies inspection and cleaning. Stainless steel drip tray for condensate collection, with G $\frac{1}{2}$ " drain connection. The duct connections have rubber seals. The duct coolers conforms to airtightness class C to EN 15727.

Operating data

Max. operating temp.: +150°C
Max. operating press.: 1,0 MPa (10 bar)
The coils are pressure tested and tested for leakage.

Capacity

Examples of capacity for each size are given on pages 6 and 7. You can also do your own calculations using our web-based VEAB Select calculation program (www.veab.com), or get in touch with our sales technicians for assistance.

Installation

The CFK is designed for installation in a horizontal duct.

Control

See pages 8 to 10 for a list of regulators, sensors, valves and actuators.

Air tightness class C

The CFK duct cooler conforms to air tightness class C, which ensures that the heated air will reach its destination and will not leak out of the ventilation system – which saves energy and money.



Product range overview and dimensions

Type	∅ D mm	B mm	H mm	∅ dy mm	F mm	G mm	K mm	L mm	Coil inside volume l	Weight kg
CFK 125-3-2.5	125	404	328	10	175	35	366	436	0.4	10,8
CFK 160-3-2.5	160	404	328	10	175	40	368	448	0.4	10,8
CFK 200-3-2.5	200	489	403	22	250	40	368	448	0.7	15,8
CFK 250-3-2.5	250	564	478	22	325	40	380	460	1.1	20,9
CFK 315-3-2.5	315	639	553	22	400	40	382	462	1.61	28,1
CFK 400-3-2.5	400	789	581	22	425	55	380	490	2.5	38

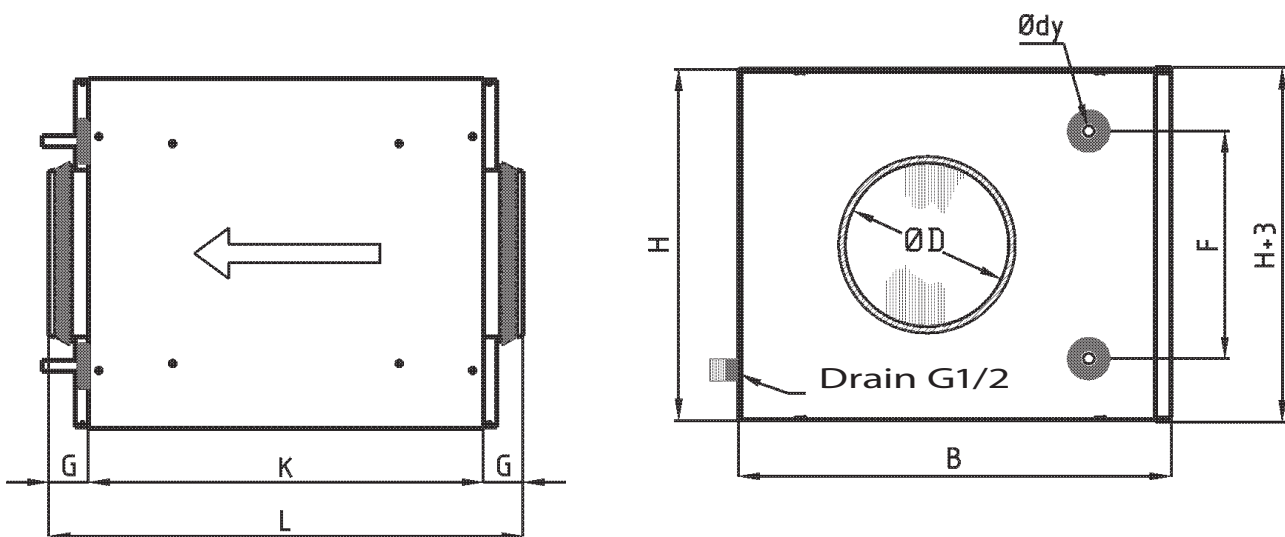

CWK / CFK

Project design/ordering

Descriptive text for - CFK

Duct heaters, VEAB type CFW with 50 mm mineral wool insulated, double-jacket casing in aluzinc-treated steel plate, AZ 185, battery insert with copper pipe and pipe connections and aluminium louvres. Stainless steel drip tray for condensate. The duct cooler conforms to air tightness class C. The cooler is controlled by an external regulator, sensors, valves and actuators, which must be ordered separately.

Type designation CFK 125 - 3 - 2.5

(example)

Size designation

Number of tube rows

Fin pitch, mm

Specify the following for project ordering:

1. Air flow rate: - m³/h
2. Inlet air temperature: - °C
3. Outlet air temp. or required output: - °C or kW
4. Duct size: - mm
5. Inlet water temperature: - °C
6. Outlet water temp. or water flow: - °C or l/sec
7. Inlet air humidity: - % RH
8. Anti-freeze agent: - type / %

Capacity CWK 100-3-2,5

Water temperature 6/12°C

Air flow	Press. drop	Inlet air temp.	Inlet air humidity	Outlet air temp.	Output	Water flow	Water press. drop
m ³ /h	Pa	°C	% RH	°C	kW	l/s	kPa
54	8	25	50	13,4	0,2	0,01	0,3
54	8	30	45	15,0	0,3	0,01	0,6
100	19	25	50	15,4	0,3	0,01	0,6
100	20	30	45	17,5	0,5	0,02	1,2
145	36	25	50	16,6	0,4	0,02	0,9
145	36	30	45	19,0	0,6	0,02	1,7

Capacity CWK 125-3-2,5 / CFK 125-3-2,5

Water temperature 6/12°C

Air flow	Press. drop	Inlet air temp.	Inlet air humidity	Outlet air temp.	Output	Water flow	Water press. drop
m ³ /h	Pa	°C	% RH	°C	kW	l/s	kPa
85	5	25	50	11,8	0,5	0,02	2,2
85	5	30	45	12,4	0,7	0,03	4,5
150	10	25	50	13,2	0,7	0,03	4,6
150	10	30	45	14,1	1,1	0,04	10,3
215	17	25	50	14,0	0,9	0,04	7,7
215	18	30	45	15,3	1,4	0,06	16,7

Capacity CWK 160-3-2,5 / CFK 160-3-2,5

Water temperature 6/12°C

Air flow	Press. drop	Inlet air temp.	Inlet air humidity	Outlet air temp.	Output	Water flow	Water press. drop
m ³ /h	Pa	°C	% RH	°C	kW	l/s	kPa
145	9	25	50	13,1	0,7	0,03	4,4
145	10	30	45	13,9	1,1	0,04	9,8
250	21	25	50	14,4	1,1	0,04	9,4
250	22	30	45	15,9	1,6	0,06	20,2
355	38	25	50	15,3	1,3	0,05	14,6
355	40	30	45	17,3	2,0	0,08	31,2

Capacity CWK 200-3-2,5 / CFK 200-3-2,5

Water temperature 6/12°C

Air flow	Press. drop	Inlet air temp.	Inlet air humidity	Outlet air temp.	Output	Water flow	Water press. drop
m ³ /h	Pa	°C	% RH	°C	kW	l/s	kPa
255	9	25	50	13,4	1,2	0,05	2,5
255	9	30	45	14,1	1,9	0,07	5,8
390	16	25	50	14,2	1,7	0,07	4,7
390	17	30	45	15,5	2,5	0,10	10,3
555	29	25	50	15,1	2,1	0,08	7,4
555	30	30	45	16,8	3,2	0,13	16,1

Capacity CWK 250-3-2,5 / CFK 250-3-2,5

Water temperature 6/12°C

Air flow	Press. drop	Inlet air temp.	Inlet air humidity	Outlet air temp.	Output	Water flow	Water press. drop
m ³ /h	Pa	°C	% RH	°C	kW	l/s	kPa
360	7	25	50	13,1	1,7	0,07	2,3
360	8	30	45	13,6	2,7	0,11	5,4
630	17	25	50	14,1	2,7	0,11	5,3
630	18	30	45	15,4	4,1	0,16	11,5
900	29	25	50	15,0	3,5	0,14	8,4
900	31	30	45	16,8	5,3	0,21	17,8

Capacity CWK 315-3-2,5 / CFK 315-3-2,5

Air flow	Press. drop	Inlet air temp.	Inlet air humidity	Outlet air temp.	Output	Water flow	Water press. drop
m ³ /h	Pa	°C	% RH	°C	kW	l/s	kPa
560	8	25	50	12,8	2,8	0,11	3,4
560	9	30	45	13,6	4,3	0,17	7,4
985	19	25	50	14,1	4,3	0,17	7,3
985	20	30	45	15,6	6,4	0,26	15,5
1410	34	25	50	15,1	5,5	0,22	11,5
1410	35	30	45	16,9	8,2	0,32	24,0

Capacity CWK 400-3-2,5 / CFK 400-3-2,5

Water temperature 6/12°C

Air flow	Press. drop	Inlet air temp.	Inlet air humidity	Outlet air temp.	Output	Water flow	Water press. drop
m ³ /h	Pa	°C	% RH	°C	kW	l/s	kPa
900	10	25	50	13,2	4,3	0,17	3,1
900	10	30	45	14,1	6,6	0,26	6,7
1590	23	25	50	14,6	6,5	0,26	6,5
1590	24	30	45	16,1	9,9	0,39	13,8
2280	42	25	50	15,5	8,3	0,33	10,1
2280	43	30	45	17,5	12,5	0,49	21,1

Regulators



AQUA24TF



RC



RC-DO



OPTIGO OP10

AQUA

Complete regulator with built-in room sensor. Floating control for controlling three-position actuators. Cascade connection with minimum limit for room temperature control. Can be equipped with external room and/or duct sensor and external setpoint adjustment. Temperature range 0 - 30°C, depending on the sensor employed.

AQUA24TF

24V supply. The regulator has a built-in controlling anti-freeze protection with two alarm relays and automatic control for heating during stoppage.

REGIO MINI

Complete regulator with built-in room sensor. Can be equipped with external room and/or duct sensors. Has two control outputs, e.g. for heating and cooling in sequence.

RC

24V supply. 0...10V output control signal. DIP switches are used for basic 20 - 26°C setpoint setting. The basic setting can be adjusted by $\pm 3^\circ\text{C}$ by means of the setpoint knob.

RC-DO

24V supply. 0...10V output control signal. The RC-DO has a back-lit display and a temperature range of 0 - 50°C.

OPTIGO

Regulator with display. One knob for all settings. For mounting on DIN rail. Operates with PT1000 sensor in the range of -20°C to $+40^\circ\text{C}$. Started/stopped with "run" signal from the fan.

OP5

24V supply. 0...10V control signal output. Operates with one sensor (room or duct sensor). Can be reset for heating or cooling control.





OP10

24V supply. Can be reset for 0...10V control signal output or 3-point control. Two control outputs, e.g. for heating and cooling in sequence. Input for two sensors and anti-freeze sensor. Supply air temperature control or room temperature control with cascade-controlled supply air. Anti-freeze control with heating during stoppage. Output, e.g. for starting/stopping of fans via 230V~, 5A relay. Programmable one-week timer for controlling of both fan and heating/cooling. Terminal for external timer that extends the operating time. Can be equipped with external setpoint adjuster.





OP10-230

Same functions as the OP10, but with 230V~ supply.

Accessories for AQUA

	Product	Range	Design
	Duct sensor TG-K330	0-30°C	Degree of protection IP20
	Room sensor TG-R430 with setpoint adjustment	0-30°C	Degree of protection IP30
	Room sensor TG-R530	0-30°C	Degree of protection IP30
	Room sensor TG-R630	0-30°C	Degree of protection IP54
	Trafo 60 Totally enclosed transformer for wall mounting. Built-in two- pole fuse on secondary side.		Primary voltage 230V~ Secondary voltage 24V~ Max. rating 60 VA Degree of protection IP44

Accessories for OPTIGO and REGIO

	Product	Range	Design
	Duct sensor TG-K3/PT1000	-30...+70°C	Degree of protection IP20
	Room sensor TG-R5/PT1000	0-50°C	Degree of protection IP30
	Room sensor TG-UH/PT1000	-30...+120°C	Degree of protection IP65
	Trafo 60 Totally enclosed transformer for wall mounting. Built-in two- pole fuse on secondary side.		Primary voltage 230V~ Secondary voltage 24V~ Max. rating 60 VA Degree of protection IP44

Actuators and valves for Kv 0.25 – 8.0 (110°C max)

Description	Type
3-position actuator for ZTV/ZTR valves, degree of protection IP44	RVAZ4-24
Actuator for 0...10V signal for ZTV/ZTR valves, degree of protection IP44	RVAZ4-24A

Description	Kv	Type
2-way ½" valve	0.25	ZTV15-0.25
2-way ½" valve	0.4	ZTV15-0.4
2-way ½" valve	0.6	ZTV15-0.6
2-way ½" valve	1.0	ZTV15-1.0
2-way ½" valve	1.6	ZTV15-1.6
2-way ¾" valve	2.0	ZTV20-2.0
2-way ¾" valve	2.5	ZTV20-2.5
2-way ¾" valve	4.0	ZTV20-4.0
2-way ¾" valve	6.0	ZTV20-6.0
2-way 1" valve	8.0	ZTVB25-8.0
3-way ½" valve	0.25	ZTR15-0.25
3-way ½" valve	0.4	ZTR15-0.4
3-way ½" valve	0.6	ZTR15-0.6
3-way ½" valve	1.0	ZTR15-1.0
3-way ½" valve	1.6	ZTR15-1.6
3-way ¾" valve	2.0	ZTR20-2.0
3-way ¾" valve	2.5	ZTR20-2.5
3-way ¾" valve	4.0	ZTR20-4.0
3-way ¾" valve	6.0	ZTR20-6.0
3-way 1" valve	8.0	ZTRB25-8

Actuator RVAZ4-24



Valve ZTV



Valve ZTR



Guide for selection of valves and actuators for CWK / CFK coolers

110°C max. water temperature

Actuator RVAZ4-24 (3-position) or RVAZ4-24A (0...10V) can be used for all ZTV/ZTR valves.

Type of CWK / CFK	Valve type	Kv
CWK 100-3-2,5	2-way ZTV15-0,4	0.4
CWK 125-3-2,5 CFK 125-3-2,5	2-way ZTV15-0,4	0.4
CWK 160-3-2,5 CFK 160-3-2,5	2-way ZTV15-0,4	0.4
CWK 200-3-2,5 CFK 200-3-2,5	2-way ZTV15-0,6	0.6
CWK 250-3-2,5 CFK 250-3-2,5	2-way ZTV15-1,0	1.0
CWK 315-3-2,5 CFK 315-3-2,5	2-way ZTV15-1,6	1.6
CWK 400-3-2,5 CFK 400-3-2,5	2-way ZTV20-2,5	2.5

Pressure drops across valves

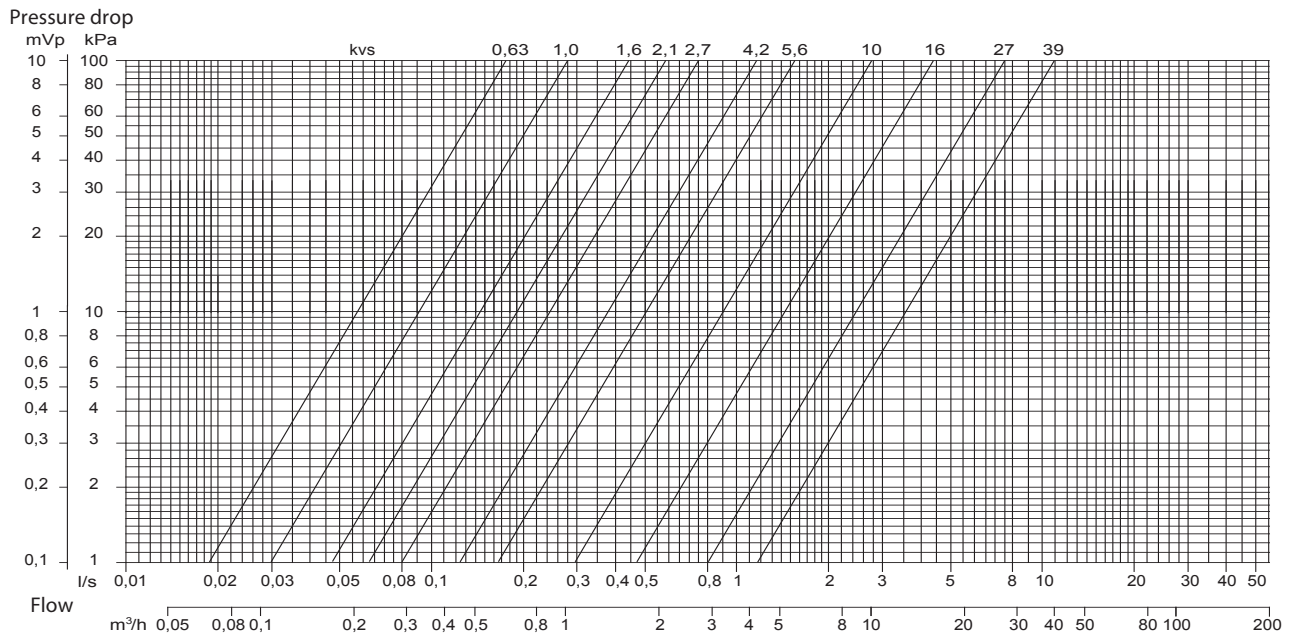



VEAB Heat Tech AB
Phone: +46(0)451-485 00 • Fax: +46(0)451-410 80
www.veab.com • veab@veab.com
Sweden