

# Flexit K2.1

ART.NO. 700114, 700116, 7000118, 700119, 700122, 700123, 700124, 700126



Flexit K2.1 ventilation unit for installation in the kitchen above the cooker. Suitable for flats, studio flats, terraced houses and small detached houses.

The ventilation unit has an integrated kitchen hood and a highly efficient rotating heat recovery system.

Balanced ventilation. A kitchen component with effective removal of cooking odours.

## Product description

- Component efficiency (EN308), heat recovery over 80%.  
Specific fan power (SFP) in the ventilation system lower than 1.5.
- Installation in the kitchen.
- One of the quietest on the market.
- Simple to operate, change filters and maintain.
- Provides balanced ventilation with an extremely good indoor climate.
- Modern, functional design. White or stainless steel finish.
- Option of communication by Modbus.
- Efficient and reliable – even in the cold.

	GTIN	Model
700114	7023677001142	K2.1 RER right model, white
700116	7023677001166	K2.1 REL left model, white
700118	7023677001180	K2.1 REL left model, stainless steel
700119	7023677001197	K2.1 RER right model, stainless steel

## Technical data

		EC 700 W
POWER	Rated voltage (AC 50Hz)	230 V
	Frequency	50 Hz
	Fuse size	10 A
	Rated current	3,8 A
	Rated power, total	875 W
	Rated power, max. electric battery	700 W
	Rated power, fans	173 W
	Rated power, rotor motor	2 W
	Lighting, compact fluorescent tube	11 W/G23

VENTILATION	Fan type	B-wheel
	Fan motor control	0-10 V
	Max. fan speed RPM	3 690 (3 200)
	Automatic control, standard	CS 60
	Protection rating	IP21
	Filter class	ePM1 55% (F7)
	Filter type (supply air/extract air)	Compact filter

DIMENSIONS	Filter dimensions (WxHxD)	130 x 335 x 50 mm
	Weight, ventilation unit	57 kg
	Weight, rotor	6,4 kg
	Weight, door	9,6 kg
	Weight, fan	2,7 kg
	Duct connection	Ø 125 mm (sleeve)
	Height	700 mm*
	Width	598 mm
	Depth	510 mm**

COATING	Colour	White/Stainless steel
	RAL	9016
	Gloss	25-35

\* without volume part and duct connection, see chap. 6 Dimensioned drawings in installation instructions (111140)

\*\* see chap. 6 Dimensioned drawings in installation instructions (111140)

Energy class:



CTRL 0.65

### LOCAL DEMAND CONTROL

Sensor control for different zones

**Accessories:** Advanced panel + CO<sub>2</sub> sensor/motion sensor + damper

**Result:** Increased air flow rate in zones that need it

[www.flexit.com](http://www.flexit.com)

Dimensioned drawings

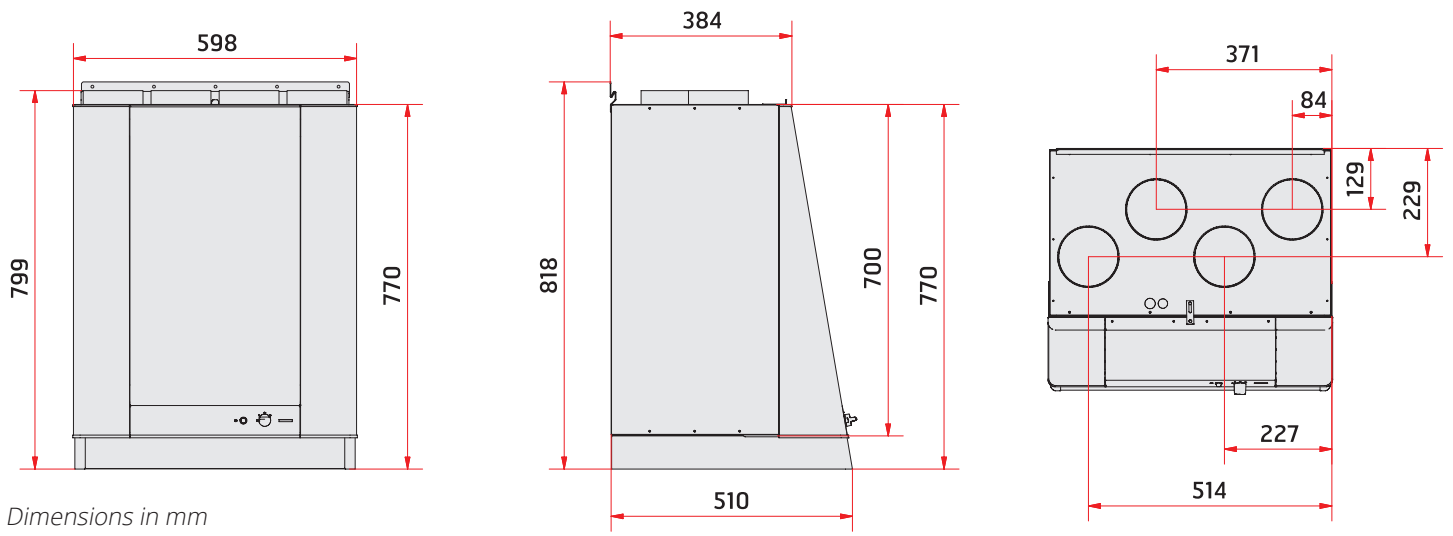

## Capacity and sound data

### Supply air side L

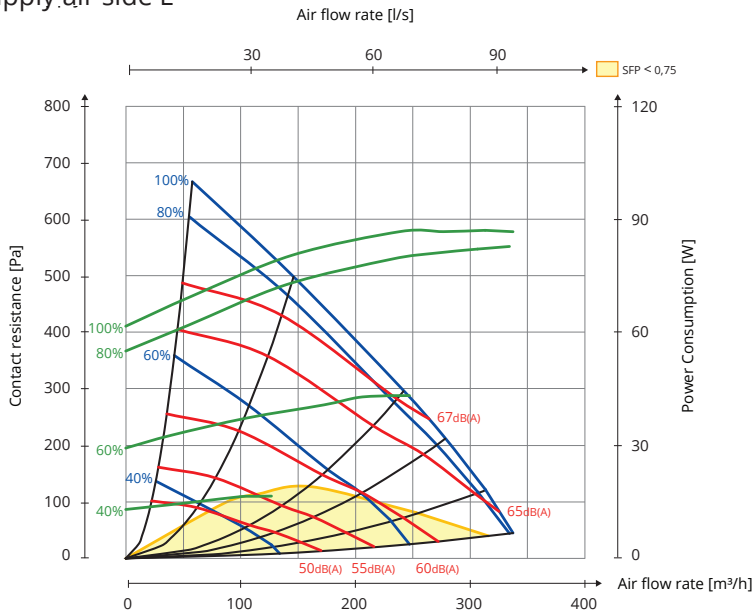

### Extract air side L

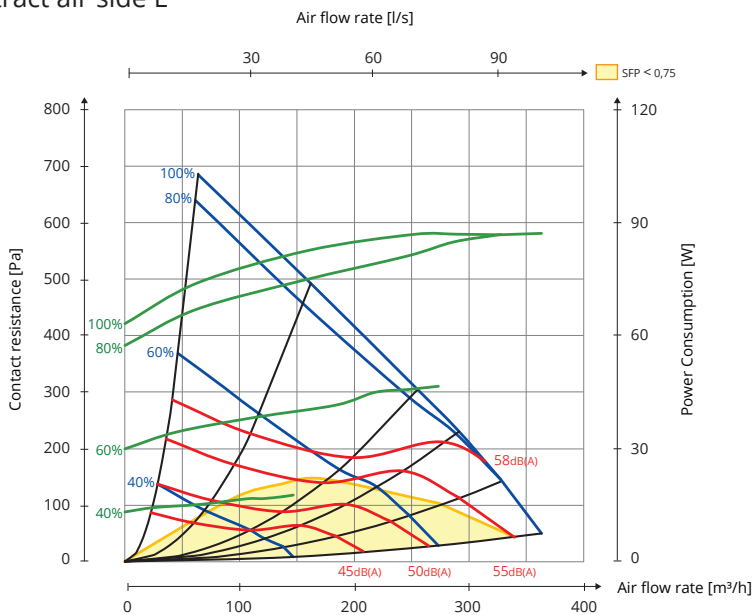

Hz	63 Lw(dB)	125 Lw(dB)	250 Lw(dB)	500 Lw(dB)	1000 Lw(dB)	2000 Lw(dB)	4000 Lw(dB)	8000 Lw(dB)	LwA (dBA)
Supply air	7	8	4	-3	-10	-13	-21	-29	
Extract air	9	11	4	-7	-14	-13	-25	-31	
Radiated 1	-3	-5	-9	-21	-28	-28	-31	-29	-14
Radiated 2	-5	-6	-13	-24	-32	-29	-39	-33	-16

Data for supply air is measured in accordance with ISO 5136, the "In-duct method". Radiated noise is measured in accordance with ISO 9614-2. Bruel & Kjaer measuring equipment, type 2260.

Radiated 1: K2 free hanging  
Radiated 2: K2 built-in kitchen

#### Explanation of diagram:

Sound data is specified as sound power level LwA in the capacity diagrams. (This is sound to duct.)

These values can be corrected by means of the table for the different octave bands in order to look at Lw (without adaptation to A band).

The correction table for the various octaves is stated in Lw, which means that the Lw values are after conversion of each octave for supply air and extract air.

Radiated sound from the unit must be calculated from the supply air diagram.

Supply air side R

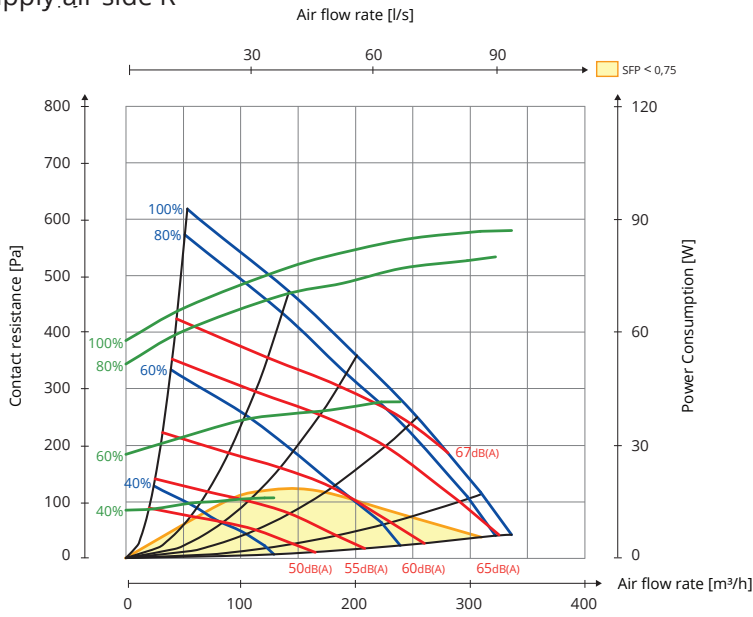

Extract air side R

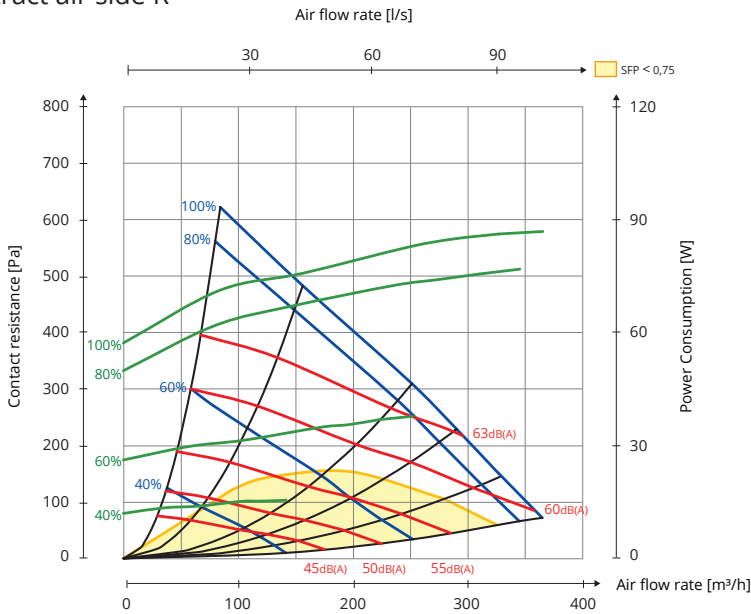

Hz	63 Lw(dB)	125 Lw(dB)	250 Lw(dB)	500 Lw(dB)	1000 Lw(dB)	2000 Lw(dB)	4000 Lw(dB)	8000 Lw(dB)	LwA (dBA)
Supply air	6	8	4	-2	-12	-11	-22	-28	
Extract air	8	10	5	-8	-15	-16	-27	-32	
Radiated 1	-3	-4	-8	-20	-27	-27	-30	-28	-14
Radiated 2	-5	-6	-13	-24	-32	-29	-39	-33	-16

Data for supply air is measured in accordance with ISO 5136, the "In-duct method".  
 Radiated noise is measured in accordance with ISO 9614-2. Bruel & Kjaer measuring equipment, type 2260.  
 Radiated 1: K2 free hanging  
 Radiated 2: K2 built-in kitchen

Explanation of diagram:

Sound data is specified as sound power level LwA in the capacity diagrams. (This is sound to duct.)

These values can be corrected by means of the table for the different octave bands in order to look at Lw (without adaptation to A band).

The correction table for the various octaves is stated in Lw, which means that the Lw values are after conversion of each octave for supply air and extract air.

Radiated sound from the unit must be calculated from the supply air diagram.

### Position

The unit is designed to be installed in the kitchen above the cooker as it has a built-in kitchen hood.

The unit is available in left and right versions (outdoor air nipple to the left or right), depending on what best matches the duct location.

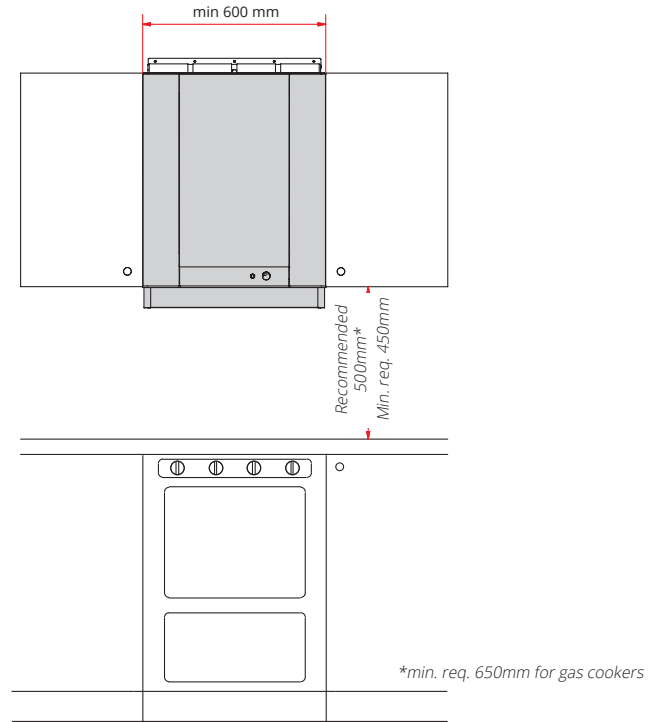

### Nipple location

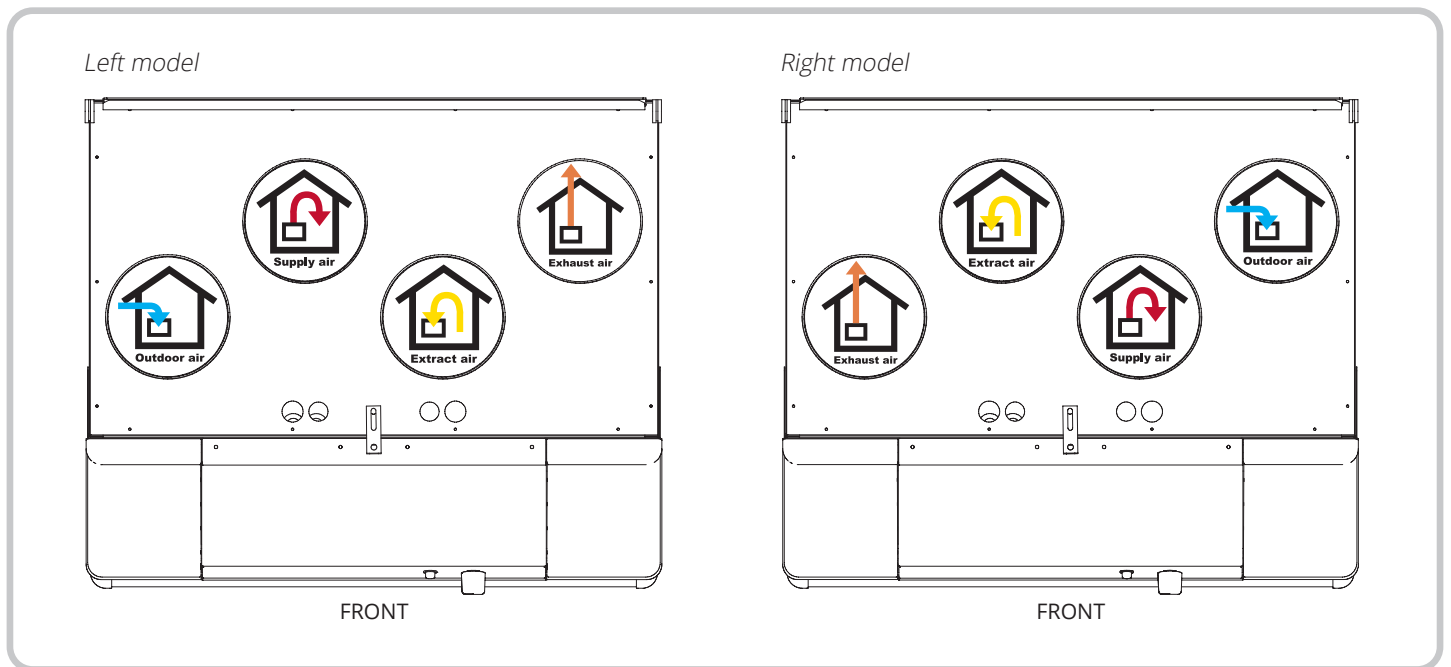

For more information on topics including installation, wiring diagrams and accessories, see [www.flexit.com](http://www.flexit.com)

*Our products are subject to continuous development and we therefore reserve the right to make changes. We also disclaim liability for any printing errors that may occur.*





Flexit participates in the ECP programme for RAHU.  
Check ongoing validity of certificate:  
[www.eurovent-certification.com](http://www.eurovent-certification.com)

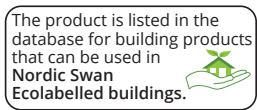

Flexit AS, Televeien 15, N-1870 Ørje  
[www.flexit.com](http://www.flexit.com)